

Team Name: \_\_\_\_\_ Team ID: \_\_\_\_\_

## 1 Kagami: Small Problems

1. [8 points]

	1	4	0	
6				0
1				5
2				4
	5	2	6	

2. [8 points]

	2	4	3	0	
3					0
2					4
10					2
1					2
	10	1	2	2	

3. [8 points]

	1	6	1	2	6	
0						2
0						6
5						0
9						0
5						1
	0	0	9	1	6	

4. [8 points]

	3	4	3	8	1	
4						10
4						1
10						9
4						8
2						9
	9	2	10	9	10	

## 2 Kagami: Big problems

5. [14 points]

	19	6	19	21	6	13	13	0	
0			2	4		1	3		0
0		1		3			4	2	13
5	1		4	2				3	13
5	4		3		1	2			1
44	3	4			2			1	6
24	2	3	1			4			1
21		2			3		1	4	8
0				1	4	3	2		0
	0	0	0	6	24	8	44	0	

6. [14 points]

	7	9	9	23	7	14	3	3	
4	\				/	\	\		3
23				\		/	/	\	3
4	/	\	/				\		14
35		/			\	\		/	1
23	\		/	\		/			11
3	\			/	/			\	1
23		/	\	/	\				15
2		\	\				/	/	0
	3	2	35	7	7	11	15	0	

### 3 Penny Pushers: Small Problems

1. [8 points]

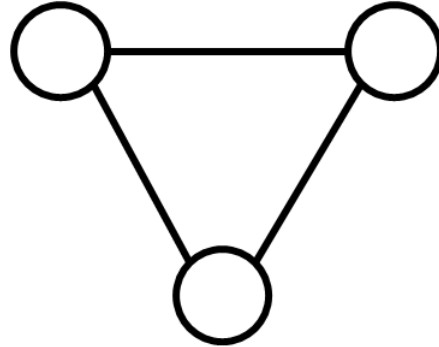
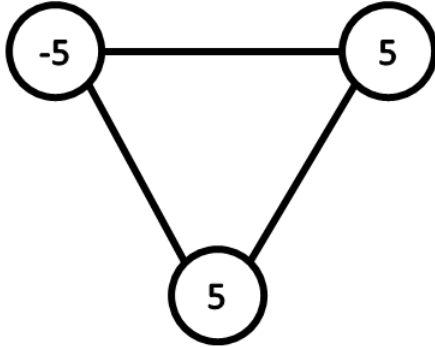

2. [8 points]

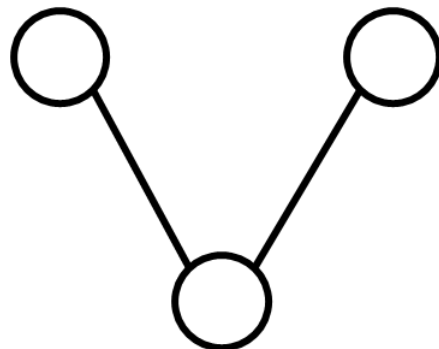
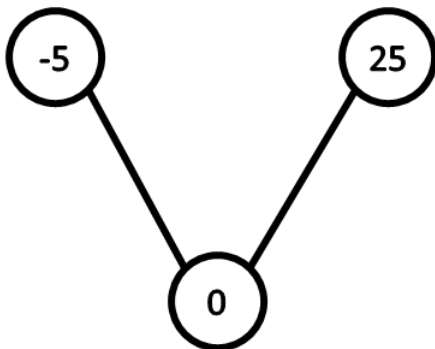

3. [8 points]

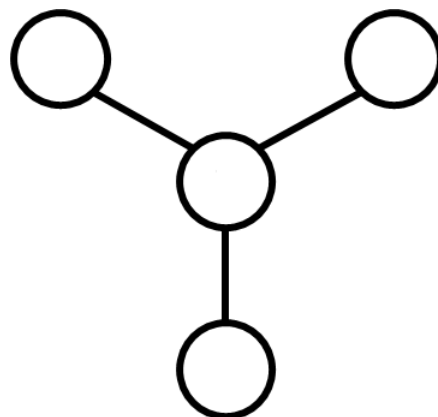
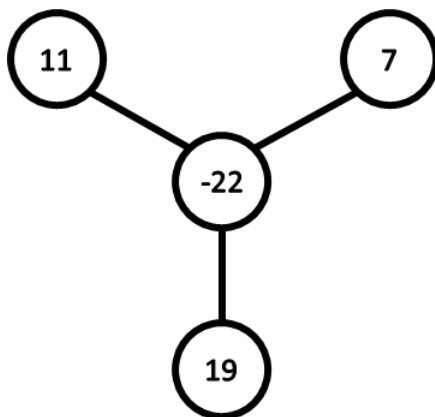

## 4 Penny Pushers: Big Problems

4. [12 points]

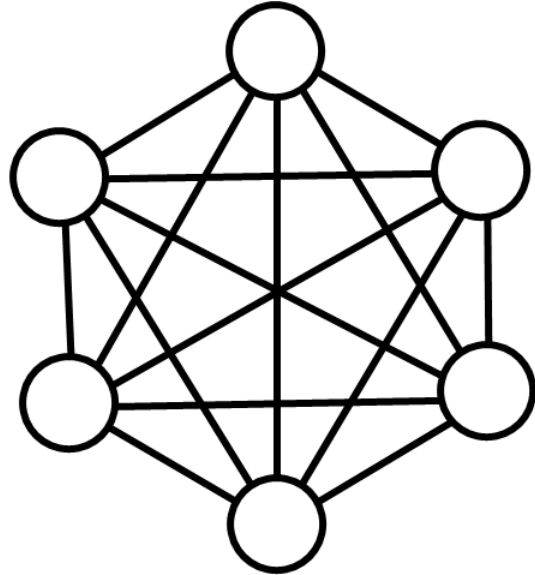
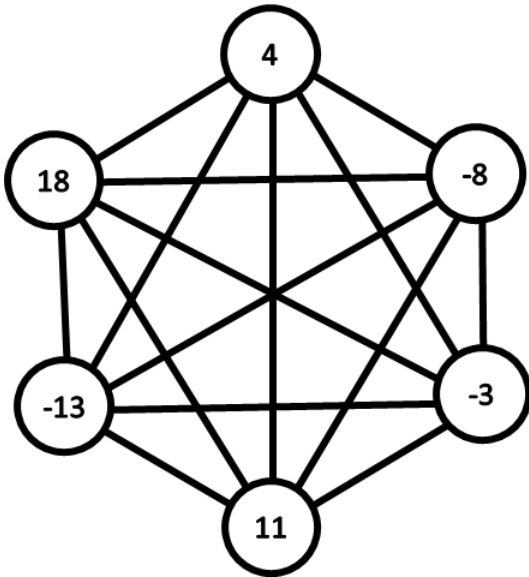

5. [12 points]

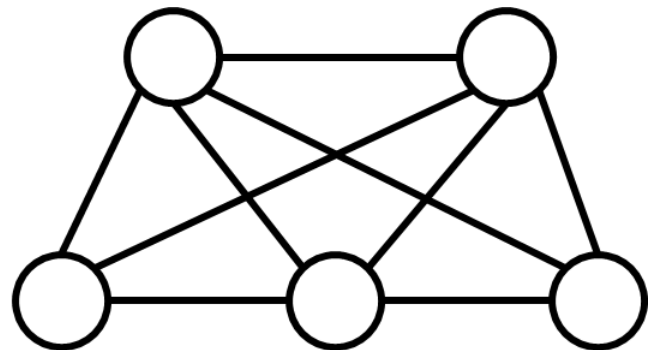
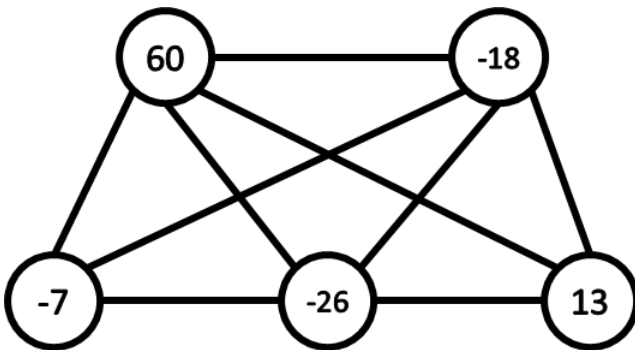

6. [12 points]

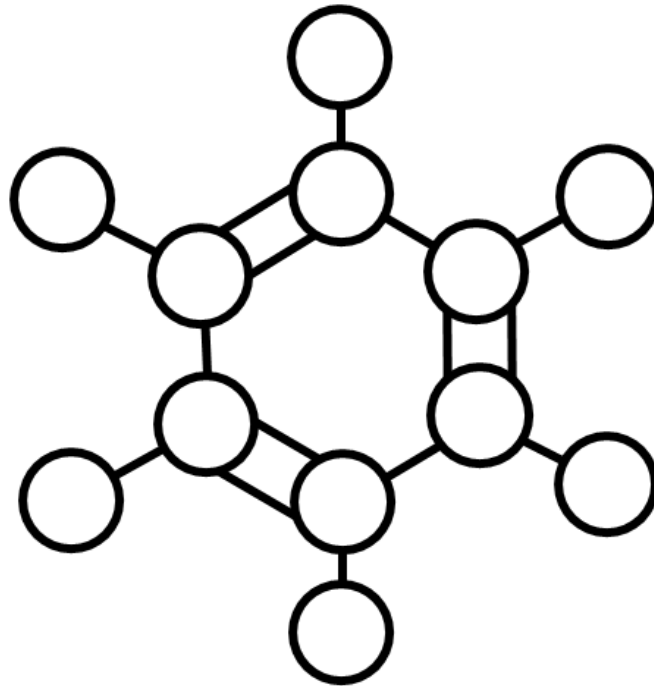
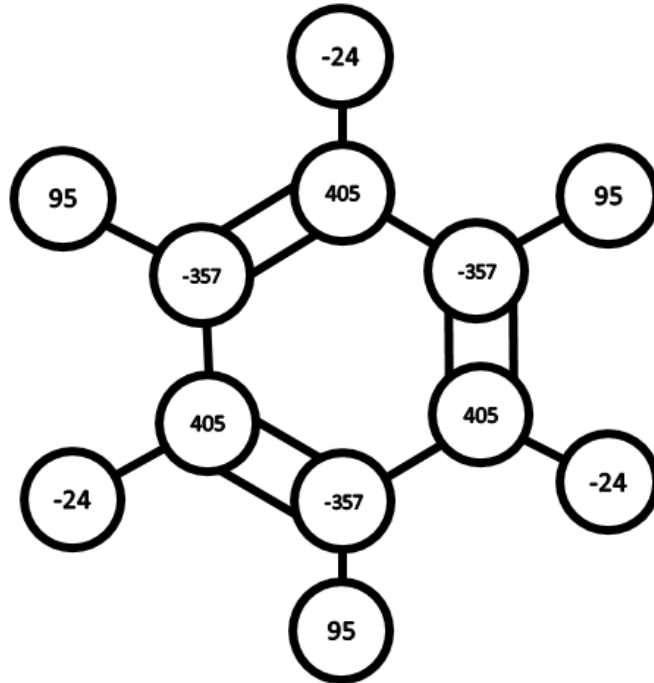

## 5 Finale

### 1. Ultimate Kagami: [10 points]

There are four solutions to this puzzle. Find one of them.

Some of the digits of the clues fell off the puzzle! Clues that had one digit fall off but not the other are underlined so you can see which digit fell off. The digits that fell off are at the bottom, and they consist of fourteen 1s, three 2s, one 4, and two numbers, each of which could be a 6 or a 9. Here is a useful hint: there are as many left-facing mirrors as there are right-facing mirrors in each row and column.

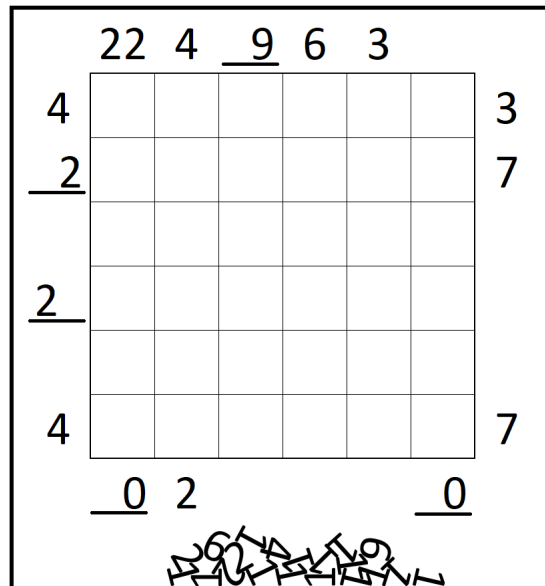

## 2. Ultimate Penny Pushers: [10 points]

In this puzzle, determine the smallest possible value of  $X$  such that this puzzle is solvable. Write that value of  $X$  in the box, and then fill in the corresponding solution below it.

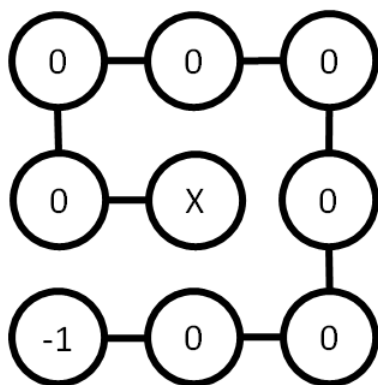

X =

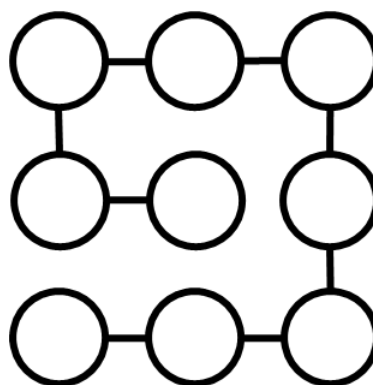

3. Ultimate Logic: [10 points]

Five people went to lunch together. The people sat in a row, seated (from left to right) on the leftmost, second, middle, fourth, and rightmost seats. Each of the five people ordered an entree and a drink. Determine the order in which the five people sat, as well as what they ordered and how much they paid for each item, with the following clues:

1. The prices of the entrees were \$2, \$3, \$5, \$7, and \$11.
2. The prices of the drinks were \$1, \$4, \$6, \$8, and \$9.
3. Grace paid \$11 for her meal.
4. Ankit ordered juice.
5. The person who ordered pizza paid \$4.
6. Justin sat in the leftmost seat.
7. The person who sat in the leftmost seat did not buy a cheeseburger and paid exactly as much as the person who bought a cheeseburger.
8. The person who bought salad also bought milk.
9. The person who bought soda sat to the left of the person who bought a hot dog.
10. Clark bought tea.
11. Coffee is more expensive than a burrito.
12. The person who bought a salad sat between Grace and the person who bought tea.
13. Lloyd spent \$11.
14. The five people were Justin, the person who bought coffee, the person who bought pizza, the person who was in the second seat, and one of the two people who paid \$11 for their meals.
15. The person who sat in the third seat didn't buy milk, but he/she paid a different amount from the person sitting in the fourth seat.

<p style="text-align: center;"><b>Receipt</b></p> <p>Customer Name: _____</p> <p>Entree: _____ ..... \$ _____</p> <p>Drink: _____ ..... \$ _____</p> <p>Seat: Leftmost Seat</p>	<p style="text-align: center;"><b>Receipt</b></p> <p>Customer Name: _____</p> <p>Entree: _____ ..... \$ _____</p> <p>Drink: _____ ..... \$ _____</p> <p>Seat: Second Seat</p>	<p style="text-align: center;"><b>Receipt</b></p> <p>Customer Name: _____</p> <p>Entree: _____ ..... \$ _____</p> <p>Drink: _____ ..... \$ _____</p> <p>Seat: Middle Seat</p>
<p style="text-align: center;"><b>Receipt</b></p> <p>Customer Name: _____</p> <p>Entree: _____ ..... \$ _____</p> <p>Drink: _____ ..... \$ _____</p> <p>Seat: Fourth Seat</p>		<p style="text-align: center;"><b>Receipt</b></p> <p>Customer Name: _____</p> <p>Entree: _____ ..... \$ _____</p> <p>Drink: _____ ..... \$ _____</p> <p>Seat: Rightmost Seat</p>